



INSTRUCTIONS FOR USE TWEHA'S BONDING SYSTEMS

version number 6.0 dated November 1, 2021



TWEHA's bonding systems are premium-grade, high-performance, moisture-cured, one-component SMP-based elastic adhesive. Cure to a tough, durable, flexible consistency with exceptional shear and tensile strength, free of solvents, isocyanates and organic tin compounds.

Characteristics

- Rock hard, durable elastic adhesive that hardens quickly under the influence of atmospheric humidity.
- Unique composition so no adhesive primer is required.
- An optimum stress distribution to panels up to a diagonal of 4.5 m¹.
- Meets fire class B-s1,d0 to EN 13501-1.
- Unprecedented design possibilities leading to simplification of the total construction.
- Resistant to moisture and weather influences, maintenance-free.
- Can be used almost year round, lower temperatures no impediment.
- Considerable increase of labor productivity.
- Durable.

Working details and design

This bonding system is meant for ventilated façade constructions. Ventilation is stipulated!

Between insulation and cladding an air space (cavity) of > 20 mm is required:

- This avoids large temperature differences in front of and behind the panels.
- Condensation and penetrating moisture are evaporated due to the ventilation.
- This prevents the formation of mould, decay or corrosion of the supporting structure or its components and the insulation material does not become damp (thermal insulating capacity is retained).
- Do not place the metal trim directly against the façade paneling! Use the TWEHA roof gutter clip!
- Consult the instructions of the panel manufacturer. TWEHA therefore advises that the upper and lower side of the façade surface be provided with the following ventilation opening: minimum 100 cm² / m¹.

Weight of the façade panels

Loads due to the weight of the panels itself are not significant when considering creep or ultimate strength. In horizontal applications such as ceilings or canopies the distance between the support rails must be reduced to 50% of the distance used in vertical application. The main support rails should be mounted square to the facade



All specifications, recommendations and technical data are based on laboratory tests under optimum conditions resp. on practical experience. They have been compiled most carefully. Nevertheless, a claim cannot be derived from them. In view of the wide range and variability of substrates, we would advise that our product should be tested by the user to establish suitability for its intended application. The user bears the only responsibility for non-appropriate or other than specified applications.

We refer to our general Conditions, technical changes reserved. Contents examined and released by TCB, Lepelstraat 1, bus 02.01, B-3290 Lommel, Belgium.

Customer Response Centre: +31 88 999 81 81 or info@tweha.com.

INSTRUCTIONS FOR USE TWEHA'S BONDING SYSTEMS

version number 6.0 dated November 1, 2021

support rails. It will also be necessary to temporarily support the panels until the adhesive is fully cured.

Wind loads

Wind loads should be determined through the applicable Regulation.
For Europe wind suction calculation according to EN 1991-1-4.

Fire behaviour

Tests performed according to EN 13823 conclude that TWEHA's Adhesives meet the fire class B-s1,d0 as described in EN 13501-1.

Durability

To ensure sustainable security, we recommend bonding on an (anodized) aluminum substructure. The use of a metal (aluminum) supporting structure is a more sustainable application than the use of a wooden supporting structure. The applicator has to meet the standards according to BRL 4104, besides working according to these Instructions for use by TWEHA.

Maximum panel size

The elastic properties of TWEHA's Bonding Systems prevent possible deformation of the façade panels due to thermal expansion. This means that façade panels with a maximum diagonal can be bonded with PanelMate.

Minimum joint width

Follow the guideline of the panel manufacturer. From an aesthetic point of view, we recommend a joint of 8 mm.

Working conditions

Possible working temperature of TWEHA's Bonding Systems is between -20°C and + 40°C. The surfaces to be bonded must be clean, dry, and free from dust and grease. During the bonding process the relative humidity must not be higher than 90% and the substrate temperature must be 3°C higher than the dew point. Note: condensation is something different than a moist surface. A moist surface is due to the surface tension, while condensation means that the moisture is on the surface as water droplets. In the event of diverging conditions we advise you to contact our helpdesk or check out at our app TWEHACalc.

Supporting wall structure

The construction of the supporting wall structure is the essential element when bonding façade cladding. The supporting structure transmits the occurring loads to the supporting wall structure of load bearing brickwork, concrete, wood etc. This supporting structure is often executed in aluminum, wood or a combination of these materials and should be tested to valid national guidelines. Fixing structures need to be installed according to manufacturers' and suppliers' instructions.

- Determine the exact dimensions of the façade surface with regard to gridlines and levels.
- Check the supporting wall structure (concrete: pressure or tension zone, or brickwork).

Aluminum supporting structure EN-AW-6060 or 6063

- Attach the supporting point and sliding point upright to each other using the designated materials.
- Cut the insulating layer where a load bearing or restraint support will be fixed (this reduces the possibility of insulation leaks!)
- In the support the vertical elements, L-, T- or sleeve profiles are connected which sustain the cladding panels.
Note: per length only one fixed anchorage-point and multiple sliding/restraint anchorage-points.
- Check the supporting structures regarding flatness and strength! The support centre-to-centre distance depends on the bending tensile strength of the panel, thickness and the panel manufacturers' instructions. Every panel has to be bonded onto a minimum of two vertical support profiles.
- The number of fixing points per m² of the supporting structure is determined by the weight of the façade panel and the wind load/ tension to the façade panels.
- The panel can be bonded directly onto the aluminum L- or T- profiles after the TWEHA Cleaner+ has evaporated.
- Note: if the aluminum profiles are provided with a coating, should be determined whether both the adhesion of the coating on the aluminum as the adhesion of the adhesive on the coating is sufficient.

INSTRUCTIONS FOR USE TWEHA'S BONDING SYSTEMS

version number 6.0 dated November 1, 2021

Wooden supporting structure

- When using a double-layer supporting structure the basic wooden structure, made of horizontally placed planed beams, they must be fixed using static tested angle brackets on top and bottom.
- Place insulation and if desired damp proof foil according to the manufacturer's instructions.
- Apply the vertical battens. The minimal thickness of the vertical supporting batten, determined by calculation, is 19 mm.

Determine the minimal thickness of the vertical supporting batten according to the applicable national guidelines.

- When bonding onto (impregnated) wood always use TWEHA WoodProtect for preservation. Please ask TWEHA for more information. Wood is a natural product and therefore has various changing components. For that reason, an adhesion test has to be performed.
- The wood must be dry (humidity percentage < 18%, drying class 2, air dried).
- Check the supporting structures regarding flatness and strength!
- For bonding onto other types of (preserved) wood: consult our helpdesk.

Basic wooden structure with black anodized aluminum Z-profile EN-AW-6060 or 6063

- When using a double-layer fixing structure the basic wooden structure, made of horizontally placed planed beams, must be fixed using static tested angle brackets on top and bottom.
- Place insulation and if desired damp proof foil according to the manufacturer's instructions.
- Apply the Z-profile. Note: one fixed anchorage and multiple restraint points by means of screws through slotted holes per length.
- Check the supporting structures regarding flatness and strength!
- The panel can be bonded directly onto the Z-profile after the TWEHA Cleaner+ has evaporated.

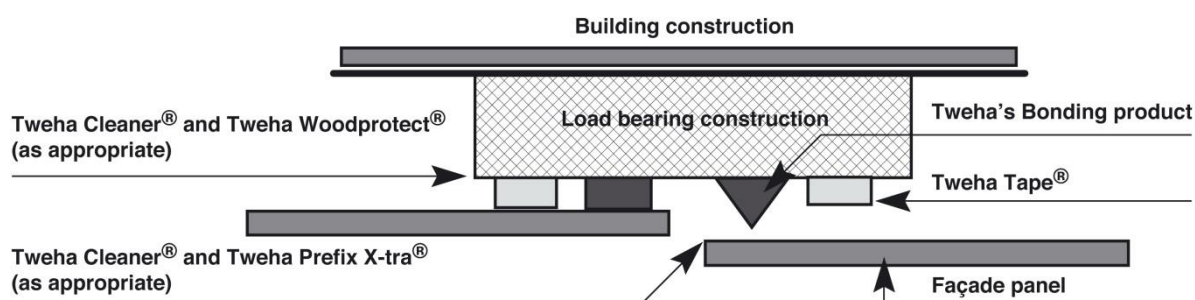

Application bonding system

| | |
|------------------------|--|
| TWEHA's Bonding System | elastic adhesive |
| TWEHA Cleaner+ | universal Cleaner+ and degreaser |
| TWEHA Tape | double sided self-adhesive foam tape for the first (temporary) bonding of the cladding thickness 3 mm, width 12 mm |
| TWEHA Prefix X-tra | surface improver for synthetic fiber cement and/or porous materials |
| TWEHA WoodProtect | preserving material for (impregnated) wood battens |
| TWEHA Blacken | coloring aluminum profiles in black |

Needed quantities, output by center-to-center distance of battens of 500 mm

| | | |
|--------------------------|--------------------------|---|
| TWEHA's Bonding System | 290 ml cartridge | ± 2,5 m ² / 7,5 m ¹ (based on a V-incision of 9x9 mm) |
| | 300 ml sausage | ± 2,5 m ² / 7,5 m ¹ (based on a V-incision of 9x9 mm) |
| | 600 ml sausage | ± 5 m ² / 15 m ¹ (based on a V-incision of 9x9 mm) |
| TWEHA Cleaner+ | 500 ml aerosol | ± 20 m ² |
| | 5 liter can | ± 200 m ² |
| TWEHA Tape | roll 25 m, 12x3 mm (w*t) | ± 8 m ² |
| TWEHA Prefix X-tra X-tra | can 1 kg (component A+B) | ± 100 m ¹ (based on 100 mm wide appl. surface) |
| TWEHA WoodProtect | can 1 liter | ± 300 m ¹ (based on batten 19 x 45 mm) |
| TWEHA Blacken | tube of 15 cl | ± 15 m ¹ (based on strip width 20 mm) |
| Holz Prof Fire Retardant | can 5 liter | ± 150 m ¹ (19*45 mm) ± 80 m ¹ (19*95 mm) |

INSTRUCTIONS FOR USE TWEHA'S BONDING SYSTEMS

version number 6.0 dated November 1, 2021

Required width of the supporting structure

| | |
|---|-------------|
| End battens and angle joints: | min. 70 mm. |
| In between battens/profiles: | min. 45 mm. |
| When open joints or joint profile applicable: | min. 95 mm. |

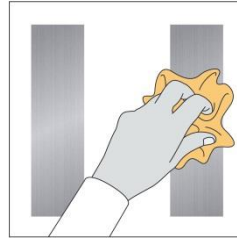
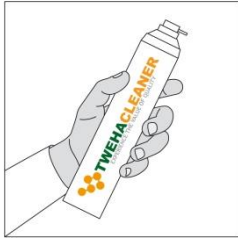

Treatment supporting structure: aluminum EN-AW-6060 of 6063

Aluminum, anodized or not, can be bonded onto directly.

- The surfaces to be bonded must be dry, dust- and grease free. To achieve this use TWEHA Cleaner+.
- Cover the front of the metal base construction with TWEHA Cleaner+ and wipe off in one direction, preferably using either plain steel wool, Brillo pads or Scotch-Brite by hand, with a hand pad block or similar. Be sure to dry the part before bonding.
- Allow the TWEHA Cleaner+ to evaporate fully for 10 minutes.
- Ensure that the treated adhesive surface is fully protected against dirt.

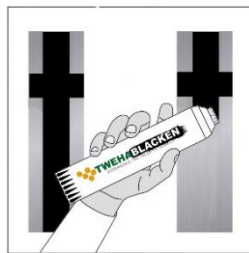

Coloring vertical profiles black

If there is a need to color the aluminum profiles in black, use TWEHA Blacken.

- The surfaces to be bonded must be dry, dust- and grease free. To achieve this use TWEHA Cleaner+.
- Cover the front of the metal base construction with TWEHA Cleaner+ and wipe off in one direction, preferably using either plain steel wool, Brillo pads or Scotch-Brite by hand, with a hand pad block or similar. Be sure to dry the part before bonding.
- Allow the TWEHA Cleaner+ to evaporate fully for 10 minutes.
- The TWEHA Blacken is easy to apply using the sponge cap supplied.
- Shake the TWEHA Blacken tube well before use.
- Apply TWEHA Blacken in one thin, full-cover layer (never more!).
- Do not use TWEHA Blacken on painted wood, multiplex, or other types of wood.
- TWEHA Blacken is not a primer and can be pre-processed. Bonding of the façade panel can take place 30 minutes after applying the TWEHA Blacken.
- Ensure that the treated adhesive surface is fully protected against dirt.

INSTRUCTIONS FOR USE TWEHA'S BONDING SYSTEMS

version number 6.0 dated November 1, 2021

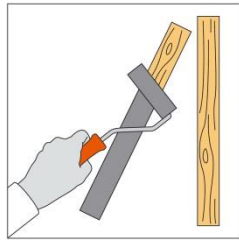
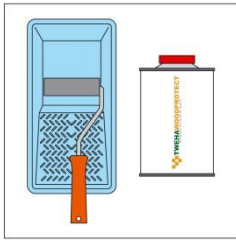

Treatment supporting structure: untreated pinewood or preserved wood

- In case of an exterior application, the untreated pinewood has to be protected all round with TWEHA WoodProtect.
- Preserved wood (creosoted, celcurised or improsol-treated as per NEN 3251/ BRL0601) has to be pre-treated on the bondable side with TWEHA WoodProtect.
- The vertical frame construction or battens must be dry (wood moisture percentage < 18%, drying class 2 (NEN-EN 5461), air dried), dust- and grease free.
- Before being attached untreated white pinewood must be treated with the wood preservation material TWEHA WoodProtect.
- For the application of TWEHA WoodProtect use a paint tray with a clean, fine structure roller. Shake TWEHA WoodProtect thoroughly before use.
- Apply TWEHA WoodProtect in one thin, full-cover layer (never more!).
- Do not use TWEHA WoodProtect on painted wood, multiplex, aluminum or other types of metal.
- TWEHA WoodProtect is not a primer and can be pre-processed. Bonding of the façade panel can take place 2 hours after applying the TWEHA WoodProtect.

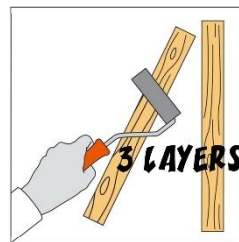
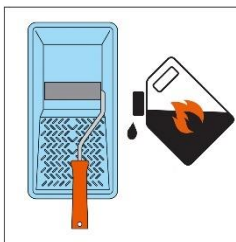

Treatment timber battening to limit the contribution of fire in case of a raging fire in a ventilated façade construction

- By treating the timber battens with HOLZ PROF FIRE RETARDANT, the fire classification of the timber facades will improve to class B-s1,d0.
- The flame retardant is highly certified on the variety of wood species: from solid wood (soft- and hardwoods) to plywood, from exotic to modified wood types.
- The vertical frame construction or battens must be dry (wood moisture percentage < 18%, drying class 2 (EN 5461), air dried), dust- and grease free.
- The product is easy to use and does not require a protective finishing coat. It is not harmful for humans, animals and the environment.
- Apply HOLZ PROF FIRE RETARDANT in three thin, full-cover layers. The application can be done with brush, roller or spray: the 3 layers can be applied at intervals of minimum 1 hour. Shake HOLZ PROF FIRE RETARDANT thoroughly before use.
- Do not process frozen wood and do not mix HOLZ PROF FIRE RETARDANT with other products..
- Do not use HOLZ PROF FIRE RETARDANT on painted wood, multiplex, aluminum or other types of metal.
- HOLZ PROF FIRE RETARDANT is not a primer and can be pre-processed. Bonding of the façade panel can take place 2 hours after applying the third layer of HOLZ PROF FIRE RETARDANT.
- HOLZ PROF FIRE RETARDANT is colorless and odorless and, if required, can be over-coated with TWEHA WoodProtect or TWEHA Blacken to obtain a black look in the joints between the façade panels.

INSTRUCTIONS FOR USE TWEHA'S BONDING SYSTEMS

version number 6.0 dated November 1, 2021

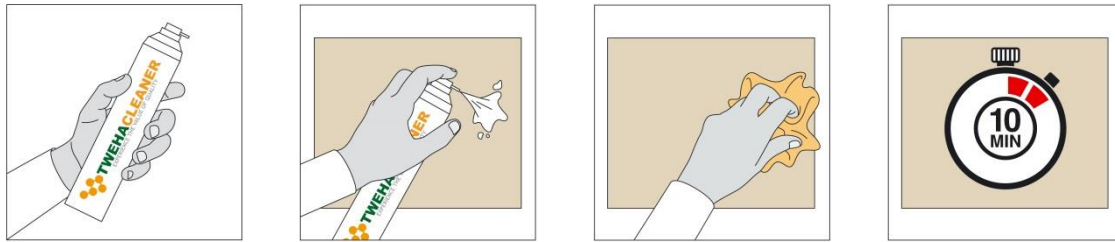

Degreasing the cladding slab with TWEHA Cleaner+

The cladding slab must be dry, clean, and free from dust and grease.

- Cover the back of the façade panel with TWEHA Cleaner+ and wipe off in one direction, preferably using a paper tissue or a clean lint free cloth.
- Allow the TWEHA-Cleaner+ to evaporate fully for 10 minutes.
- Ensure that the treated adhesive surface is fully protected against dirt.
- TWEHA Cleaner+ is not an aggressive degreaser and using it has no appreciable effect on the surface of the façade panels. Besides degreasing the surfaces to be bonded, TWEHA Cleaner+ can also be used to remove adhesive residue (before it is cured).

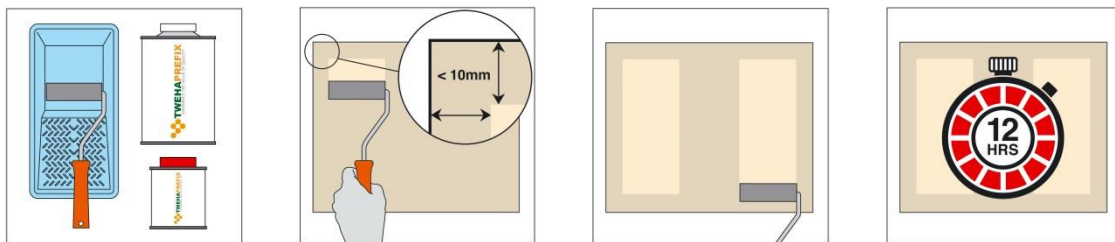

Pre-treatment of synthetic fiber cement slabs or other porous materials such as some types of natural stone with TWEHA Prefix X-tra

For optimum bonding, pre-treatment with TWEHA Prefix X-tra surface improver is necessary.

- Before treatment the façade panel must be clean, dry, and free from grease. To achieve this use TWEHA Cleaner+.
- Add the full contents of TWEHA Prefix X-tra component B (hardener) to the full contents of TWEHA Prefix X-tra component A (resin). Mix both components well for minimum 2 minutes with a stirrer until the components are evenly mixed. Then pour the substance over into a paint tray to check if the components are completely mixed. Do not add water or other products. Note: do not subdivide the supplied contents of the package!
- Apply TWEHA Prefix X-tra vertically to the area to be bonded (\pm 10 cm wide) with a brush or fine structure paint roller in one thin, but full-cover layer.
- Apply and process the TWEHA Prefix X-tra within 30 minutes! Note: bonding of the façade panels is only possible after the prescribed drying time of minimum 12 hours.
- Ensure that the treated adhesive surface is fully protected against dirt.
- The surfaces to be bonded must be dry, dust- and grease free. To achieve this use TWEHA Cleaner+.

INSTRUCTIONS FOR USE TWEHA'S BONDING SYSTEMS

version number 6.0 dated November 1, 2021

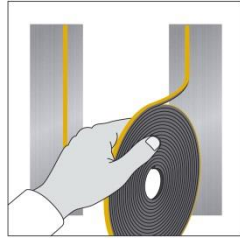
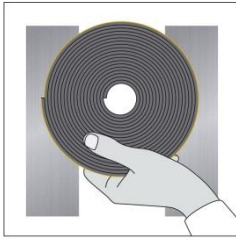

Application of TWEHA Tape

- TWEHA Tape provides the initial bond and guarantees the minimum required glue bead thickness of 3 mm.
- Apply the TWEHA Tape after complete drying of the TWEHA Cleaner+ and/or TWEHA WoodProtect.
- Position the TWEHA Tape vertically in an unbroken strip on the vertical frame construction of the (pre-treated) wood or cleaned metal. Then press down the TWEHA Tape firmly and cut with a sharp knife. For the correct positioning and the length of the TWEHA Tape take into account the size of the support posts, the dimensions of the façade panel and the necessary space for the glue bead. Remove the protective layer only after applying the glue bead!

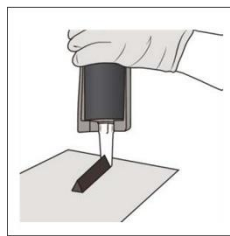
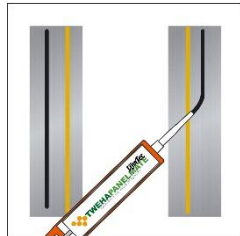

Apply glue bead

- To obtain the prescribed glue width/thickness of minimum 12 x 3 mm use the supplied nozzle or otherwise cut a standard nozzle in an V-shape of minimum 8 x 8 mm. The V-shape is necessary to prevent air bubbles being trapped and unnecessary loss of adhesion.
- Then cut open the cartridge or sausage, fit the nozzle and by using a glue gun apply the glue bead.
- Apply the adhesive 10 mm away from to the TWEHA Tape in an unbroken required V-shape bead.
- Place the façade panel within 10 minutes, otherwise a skin will form on the adhesive!

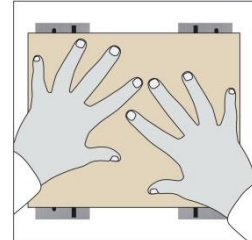
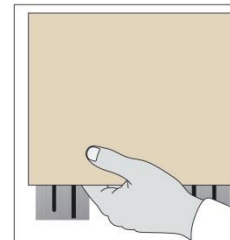
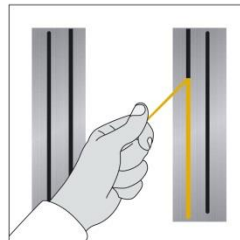
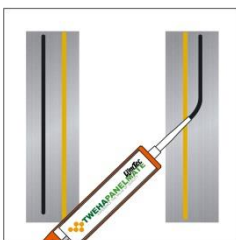

Attach façade panel

- Check the supporting structures regarding flatness and strength! The support center-to-center distance depends on the bending and tensile strength of the type of panel, thickness and the panel manufacturers' instructions. Every slab has to be bonded onto a minimum of two vertical battens or aluminum profiles.
- After the prescribed drying time of TWEHA Cleaner+ and, if applicable, TWEHA-Prefix X-tra the façade panel can be applied.
- Remove the protective layer from the TWEHA Tape.
- Press the cleaned side of the panel gently against the adhesive to enable subsequent correction. Press down the panel firmly when it is correctly positioned, so that the façade panel makes good contact with the TWEHA Tape.

INSTRUCTIONS FOR USE TWEHA'S BONDING SYSTEMS

version number 6.0 dated November 1, 2021

- To achieve an optimum ventilation, use the TWEHA RoofGutter Clip!

Guarantee

TWEHA guarantees that their bonding systems meets the technical specifications as described in the relevant technical information sheets.

Primary conditions:

- The applier has to meet and follow the instructions for use from TWEHA and the guidelines from the panel manufacturer.
- The products are used as a system.
- Processing is carried out strictly in conformity with the processing guidelines, unless it can be reasonably assumed that in a particular case this is not (fully) justified: in this case contact our helpdesk and always ask for a written confirmation of an application method which deviates from the guidelines!

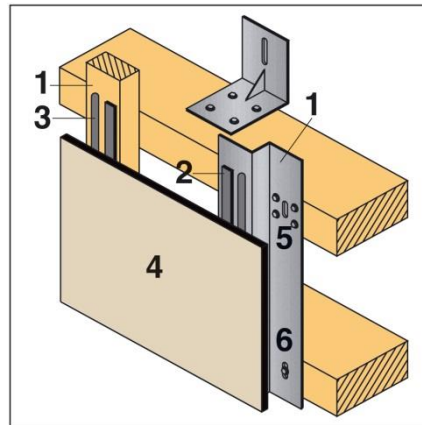
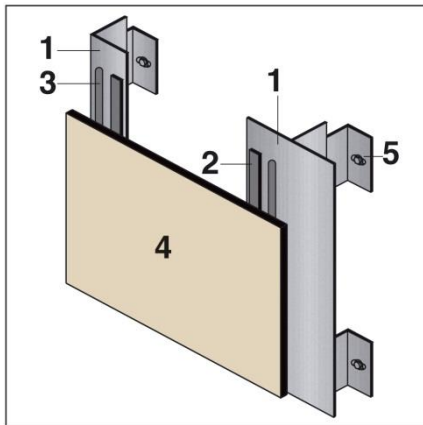

Explanation of numbers

- 1 Wood, Aluminum L-, T-profile or Z-profile
- 2 TWEHA Tape
- 3 TWEHA's Adhesive
- 4 Façade cladding
- 5 Supporting point
- 6 Sliding point

| | TWEHA's bonding systems | TWEHA Tape | TWEHA Cleaner+ | TWEHA WoodProtect | TWEHA PreFix X-tra | TWEHA Blacken |
|----------------------|--------------------------------|-----------------------|---------------------------|----------------------------|---|--------------------|
| signature | silane modified polymer | double sided foamtape | cleaner and degreaser | protect non-preserved wood | surface improver | blacken aluminum |
| colour | black/grey/white | grey | transparent | black | transparent | black |
| working temperature | -20 to +40 °C (-4 to +99.2 °F) | | | | | |
| type of surface | every surface | | | non preserved wood | synthetic fiber cement or other porous material | aluminum |
| condition of surface | clean, dry and free of grease | | n.a. | | clean, dry and free of grease | |
| drying time | 2.5 to 3 mm/24 hrs | n.a. | 5-10 minutes to evaporate | 2 hrs. | 12 hrs. | 30 min. |
| packaging | 12 pcs. 290 ml cartridge | 12 pcs. roll 25 m | 12 pcs. aerosol 500 ml | can 1 ltr. | 2 component, 1 kg. | 5 pcs. tube 30 cc. |
| | 12 pcs. 300 ml foil pack | | can 5 ltr. | | | |
| | 12 pcs 600 ml foil pack | | | | | |
| shelf life | 18 months * | 24 months | | | 18 months | |
| details | apply within 15 minutes | | none | woodmoisture < 18% | apply within 30 minutes | |

* in original closed and undamaged packaging stored at a cool and dry place.

For detailed information consult the material safety data sheets on www.tweha.com

For questions please contact our helpdesk +31 88 999 81 81